

DISHWASHER

Instruction Manual

MODEL NUMBER CDC17P2AWW

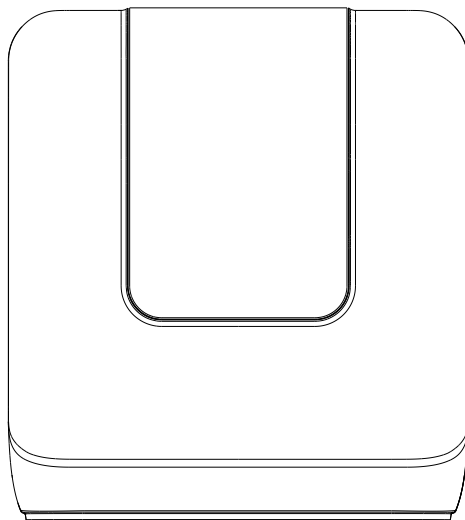

Free 3 months extension of the original limited warranty period!* Simply text a picture of your proof of purchase to:

1-844-224-1614

*The warranty extension is for the three months immediately following the completion of the product's original warranty period.

comfee'

Please keep the manual for future reference.

QUICK START GUIDE

Please read the entire manual for detailed operating instructions.

Connecting to Power Supply

The power required is 120VAC 60Hz, 10Amp circuit.

Drain hose installation

Place the end of the drain Hose into a sink or bucket.

Remove the rubber plug from the drain pipe at the rear of the machine. Install one end of drain hose to the drain pipe at the rear of the machine and then tighten the drain hose clamp by hand to secure it.

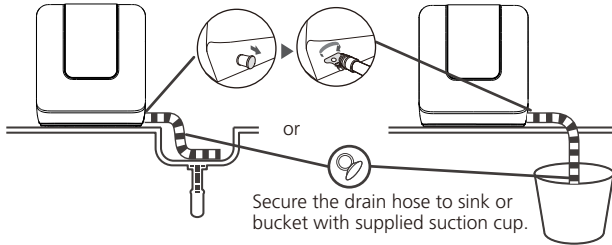

Secure the drain hose to sink or bucket with supplied suction cup.



Adding Water to the Tank

Note: Before adding water, you need to press the power button to turn on the dishwasher

There are two ways to add water into the tank:

- 1 Add water into the tank automatically by connecting inlet hose to the tap.
- 2 Open the cap and slowly add water into the tank manually by using water container.

IMPORTANT:

The water tap symbol  will be on if there is not enough water in the tank. Add water until the unit beeps rapidly for 3 seconds and  is off, which means the tank is filled.

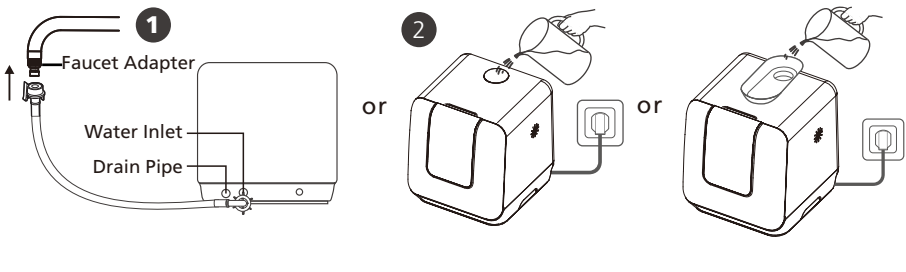

Prep the Dishware

Remove the large residue on the dishware and glasses before placing into the dishwasher.



Loading The Dishwasher

Place dishes in the dishwasher in order by size and starting from the two ends, then load into the middle. All dishes are suggested to be tilted to improve cleaning performance. The top arm will be blocked if dishes are improperly placed and the cleaning effect may not be ideal.

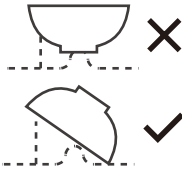
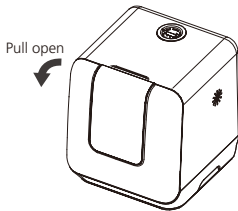

Do not place the dishes in the upright direction or the cleaning performance may be effected. Try to leave the dirty side facing towards the spray arm.

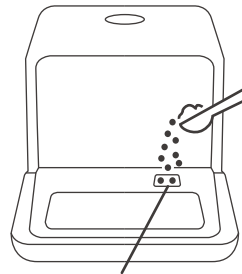

Detergent compartment. (Do not use detergent when running the FRUIT program.)

Starting The Dishwasher

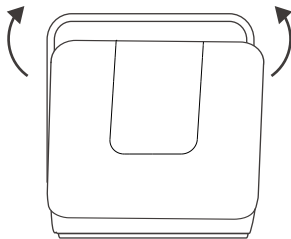

Close the front door, choose the program and press START.

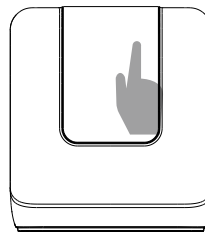

CONTENTS

Please carefully read this manual before using the dishwasher, it will help you use and maintain the dishwasher properly .

01	5	IMPORTANT SAFETY INSTRUCTIONS
02	8	GETTING TO KNOW YOUR APPLIANCE
	8	Dishwasher Features
	9	Control Panel
03	11	USING YOUR DISHWASHER
	11	Loading The Dishwasher Baskets
	14	Loading The Detergent
04	16	WASH CYCLE SELECTION
	16	Wash Cycle Programs
	17	Turning On The Appliance
	17	Change The Program
	18	Forgot To Add A Dish?
	19	End Of The Wash Cycle
	19	Forced Internal Tank Draining
05	20	MAINTENANCE AND CLEANING
	20	Filter System
	21	Dishwasher Care
	23	Dishwasher Maintenance
06	24	INSTALLATION INSTRUCTION
	24	Installation Preparation
	25	About Power Connection
	25	Water Connection
	26	Connection Of Drain Hoses
07	27	TROUBLESHOOTING TIPS
	27	Before Calling For Service
	30	Error Codes
	31	Technical Information
	32	Warranty

IMPORTANT SAFETY INSTRUCTIONS

WARNING

When using your dishwasher , follow the precautions listed below:

- Do not allow children to play with the appliance. Cleaning and user maintenance shall be made by children without supervision.
- This appliance is not intended for use by children or persons with reduced physical, sensory or mental capabilities, or lack of experience and knowledge, unless they have been given supervision or instruction concerning use of the appliance by a person responsible for their safety.
- This appliance is for indoor use only, for household use only.
- To protect against the risk of electrical shock, do not immerse the unit, cord or plug in water or other liquid.
- Please unplug before cleaning and maintaining the appliance .
- Use a soft cloth with mild soap and water to clean the exterior. Use a dry cloth to wipe dry.

Grounding instructions

- This appliance must be grounded. In the event of a malfunction or breakdown, grounding will reduce the risk of an electric shock by providing a path of least resistance of electric current. This appliance is equipped with a cord having an equipment-grounding conductor and a grounding plug.
- The plug must be plugged into an appropriate outlet that is installed and grounded in accordance with all local codes and ordinances.
- Do not modify the plug provided with the appliance. If it does not fit the outlet, have a proper outlet installed by a qualified electrician.
- Improper connection of the equipment-earthing conductor can result in the risk of an electric shock. Check with a qualified electrician or service representative if you are in doubt whether the appliance is properly grounded.

● **General use**

- Do not abuse, sit on, or stand on the door or dish rack of the dishwasher.
- Do not operate your dishwasher unless all enclosure panels are properly in place.
- Open the door very carefully if the dishwasher is operating, there is a risk of water squirting out.
- Do not place any heavy objects on or stand on the door when it is open. The appliance could tip forward.

When loading items to be washed:

1) Locate sharp items so that they are not likely to damage the door seal;

2) **Warning: Knives and other utensils with sharp points must be loaded in the basket with their points down or placed in a horizontal position.**

- Check that the detergent powder is empty after completion of the wash cycle.
- Do not wash plastic items unless they are marked dishwasher safe or the equivalent. For plastic items without mark, check the manufacturer's recommendations.
- Use only detergent additives designed for an automatic dishwasher.
- Never use soap, laundry detergent, or hand washing detergent in your dishwasher. Children should be supervised to ensure that they do not play with the appliance.
- If the supply cord is damaged, it must be replaced by the manufacturer or its service agent or a similarly qualified person in order to avoid a hazard.
- During installation, the power supply must not be excessively or dangerously bent or flattened.
- Do not tamper with controls.
- The appliance is to be connected to the water mains using new hose sets and that old hose-sets should not be reused.
- The maximum number of place settings to be washed is 2 in AHAM test, 1 setting in DOE test.
- Under certain conditions, hydrogen gas might be produced in a hot-water system that has not been used for two weeks or more. **HYDROGEN GAS IS EXPLOSIVE.** If the hot-water system has not been used for such a period, before using the dishwasher turn on all hot-water faucets and let the water flow from each for several minutes. This will release any accumulated hydrogen gas. As the gas is flammable, do not smoke or use an open flame during this time.
- Remove the door to the washing compartment when removing an old dishwasher from service or discarding it.

SAVE THESE INSTRUCTIONS

Disposal

- For disposing of package and the appliance please go to a recycling centre. Therefore cut off the power supply cable and make the door closing device unusable.
- Cardboard packaging is manufactured from recycled paper and should be disposed in the waste paper collection for recycling.
- By ensuring this product is disposed of correctly, you will help prevent potential negative consequences for the environment and human health, which could otherwise be caused by inappropriate waste handling of this product.
- For more detailed information about recycling of this product, please contact your local city office and your household waste disposal service.
- **DISPOSAL:** Do not dispose this product as unsorted municipal waste. Collection of such waste separately for special treatment is necessary.



GETTING TO KNOW YOUR APPLIANCE

IMPORTANT:

Before using this dishwasher for the first time and to get the best performance, read these instructions.

Dishwasher features

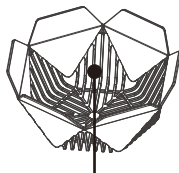
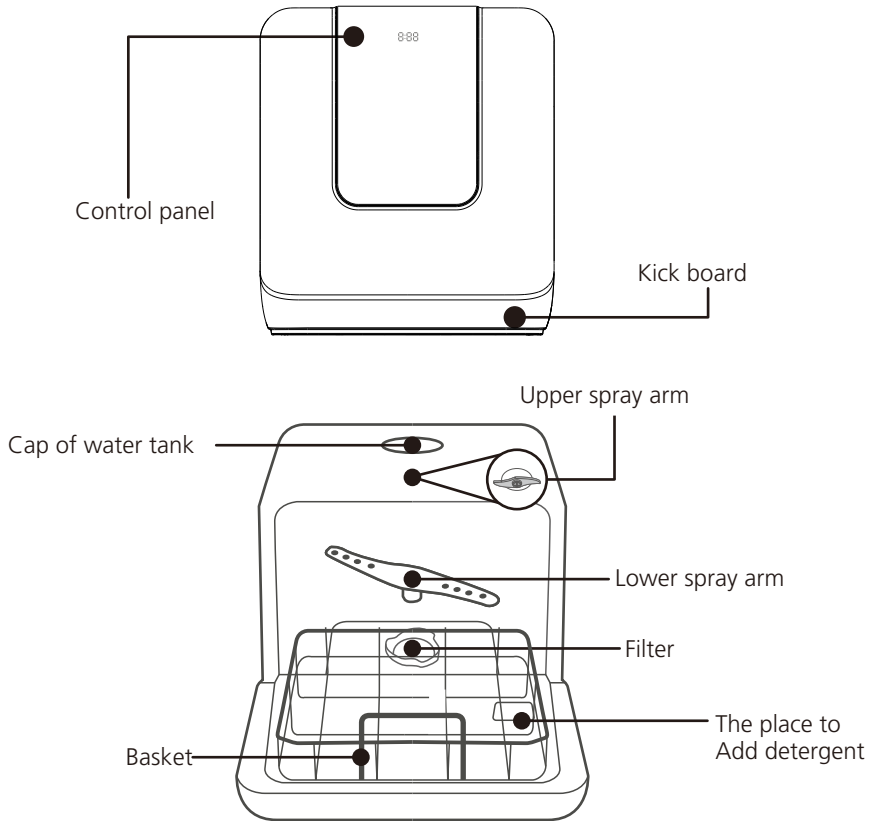

Fruit Rack



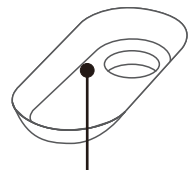

Water Container





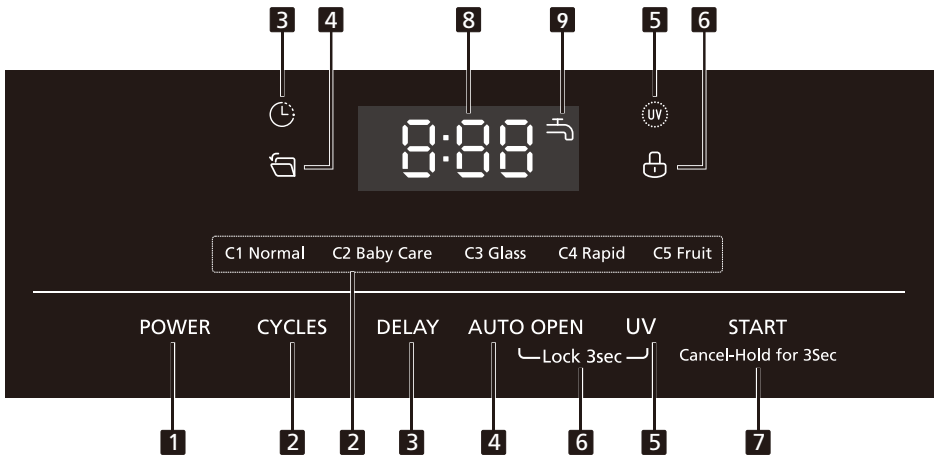

Water Filling Guide

Control panel



1 Power	Press this button to turn on your dishwasher.
2 Program	<p>Press this button to select corresponding washing program code C1 (Normal) - C2 (Baby Care) - C3 (Glass) - C4 (Rapid) - C5 (Fruit).</p> <p>C1 Normal This cycle is for normally soiled loads, such as pots, plates, glasses and lightly soiled pans.</p> <p>C2 Baby Care This cycle is for washing baby bottles.</p> <p>C3 Glass Glass cycle is for lightly soiled loads, such as glasses, crystal and fine china.</p> <p>C4 Rapid This cycle is for lightly soiled loads that do not need drying.</p> <p>C5 Fruit Used to clean fruits, vegetables, shells, etc.</p>
3 Delay	Press this button to set the delayed hours for washing. You can delay the start of washing up to 24 hours. One press on this button delays the start of washing by one hour.
4 Auto open	Press this button to activate or deactivate auto open function. When this function is on, the  light will be lit, and the dishwasher will open the door automatically in the drying phase to help drying. (It can only be used with Normal, Baby Care and Glass)

<p>5 UV</p>	<p>Press this button. the uv light will be on during the drying phase. When this function is on, the  light will be lit. (It can only be used with Normal, Baby care and Glass)</p>
<p>6 Child lock</p>	<p>This option allows you to lock the buttons on the control panel, so children cannot accidentally start the dishwasher by pressing the buttons on the panel. Only the Power button remains active. To lock or unlock the buttons on the control panel, press and hold the Auto open button+ UV button for 3 seconds simultaneously. When this function is on, the  light will be lit.</p>
<p>7 Start /Cancel</p>	<p>Start Press to start the dishwasher, the drain pump will start the cycle.</p> <p>Cancel Press and hold START for 3 seconds to cancel a cycle when the dishwasher is running. The display will show "-- : --" , indicating cycle has been canceled.</p> <p>Pause If you need to pause a cycle in process, open the door slightly and wait a few seconds until the wash action stops. To restart the dishwasher press the start button with the door closed.</p>
<p>8 Screen</p>	<p>The LED screen displays program cycle code (C1, C2,.....), minutes remaining in a running cycle, hours of delay before the unit is set to start, error codes, etc.</p> <ul style="list-style-type: none"> • If the machine is in operation, the remaining time (mins) of the selected cycle will be shown in the display window. • If the Delay option is selected, the number of hours of delay (1h-24h) will be shown in the display window. After the machine starts, the remaining time of the selected cycle will be shown in minutes on the display window. <p>NOTE: The remaining time could suddenly increase or drop several minutes. This means the Smart Sensor has checked the soil level and adjusted the number of fill cycles.</p> <ul style="list-style-type: none"> • If an error occurs which is critical to the machines function and safe operation, the control shall shut down and indicate an error code in the display window. (See Error Codes) • If Error codes are displayed, contact the dealer or qualified service center. They will available to provide assistance in trouble shooting the problem and/or locate and authorized service technician if needed.
<p>9 Water Faucet </p>	<p>When the icon  is on, it means that the internal water tank does not have enough water. Add water or check the inlet hose connections to make sure the water supply is turned on until this icon  is off, which means the tank is full of water.</p>

USING YOUR DISHWASHER

• **Loading The Dishwasher**

Recommendation

- All items to be washed should be marked "dishwasher safe".
- Use only dish detergent designed for automatic dishwashers, hand dishwasher soap will create foam and require significant clean up and issues with the dishwasher.
- For delicate items, select a program with lower temperatures.
- CAUTION: Do not take glass and cutlery out of the dishwasher immediately after the program has ended. These items will still be very hot.

Items Not Recommended for Dishwasher Use

Not suitable for use:

- Cutlery with wooden, horn, china or mother-of-pearl handles
- Plastic items that are not heat resistant, older cutlery with glued parts that are not temperature resistant
- Bonded cutlery items or dishes
- Pewter or copper items
- Crystal glass
- Steel items subject to rusting
- Wooden items
- Items made from synthetic fibres

Limited suitability:

- Some glasses can become dull after a large number of washes.
- Silver and aluminium have a tendency to discolour during washing.
- Glazed patterns may fade if washed frequently.

Dishwasher Loading Tips

(For the best performance of the dishwasher, follow these loading guidelines. Features and appearance of baskets and cutlery baskets may vary for your model.)
Scrape off any large food particles. Soften remnants of burnt food in pans. It is not necessary to rinse the dishes under running water. Place objects in the dishwasher in following way:

- Items such as cups, glasses, pots/pans, etc. load face downwards.
- Curved items, or those with recesses, should be loaded at a slant so that water can run off.
- All items inserted securely and can not tip over, or move around and contact other items.

- All utensils are placed in the way that the spray arms can rotate freely during washing.

⚠ NOTE

Very small items should not be washed in the dishwasher as they could easily fall out of the basket.

- Load items in a way that the dirty surface faces the center of the dishwasher
- Load long and/or sharp cutlery horizontally on the cutlery tray
- Avoid nesting dishes for best results(example two spoons together)
- Ensure items do not touch or move/wobble in the basket,this can cause damage to your dishes
- Do not allow items to extend below the dishwasher rack,this could cause and interference with the wash arm.
- Do not overload your dishwasher. If the water can not get to your dishes from the bottom or top wash results may be poor.

Loading The Baskets

Position the dishes and cookware so that they will not get moved by the spray of water.

Recommend loading layout with 1 serving bowl and 2 settings personal tableware.

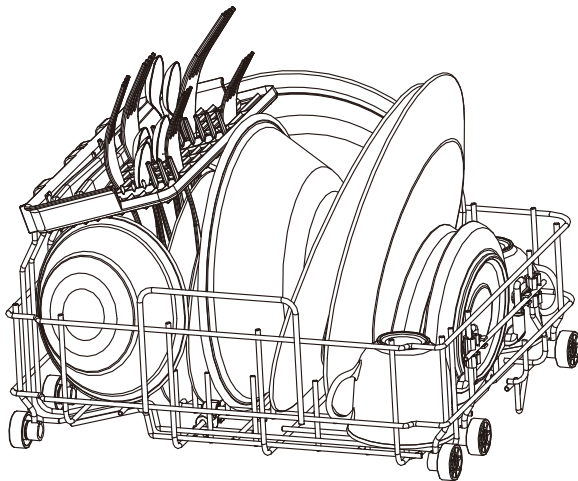



1×Serving bowl(1L)



1×Oval platter(9.5in)



1×Serving fork



2×Bread and butter plates
(6.7in)



2×Dinner plates(10in)



2×Dessert bowls(5in)



2×Saucers(5.5in)



2×Cups



2×Glasses(12.5OZ)



2×Serving spoons



2×Dinner forks



2×Salad forks



2×Knives



2×tea spoons

Folding Down The Rack Shelves

The tines are used for holding plates and a platters. They can be lowered to make more room for large items, such as large size tableware or the fruit basket or the baby bottle rack.

raise upwards

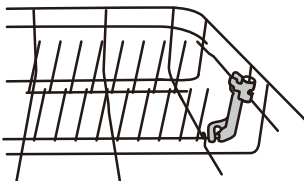

fold downwards

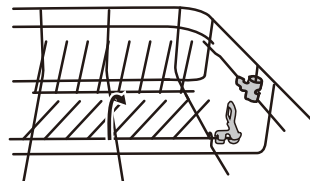

• Loading The Detergent

This product do not support rinse aid. Only add detergent.

⚠ WARNING

- **Only use detergent specifically for dishwashers.**
Never use any other rinse aid and detergents.
This will damage the appliance.
-  **Dishwasher detergent is corrosive!
Keep dishwasher detergent out of the reach of children.**

Detergent Tablets

Detergent tablets of different brands dissolve at different speeds. For this reason some detergent tablets will not dissolve and develop their full cleaning power during short programs. Therefore please use long programs when using detergent tablets, to ensure the detergent tablet dissolves completely.

Detergent

The detergent must be refilled before the start of each wash cycle following the instructions provided in the Wash Cycle Table. Your dishwasher uses less detergent than conventional dishwasher. Generally, only one tablespoon of detergent is needed for a normal wash load. More heavily soiled items need more detergent. Always add the detergent just before starting the dishwasher.

Adding detergent

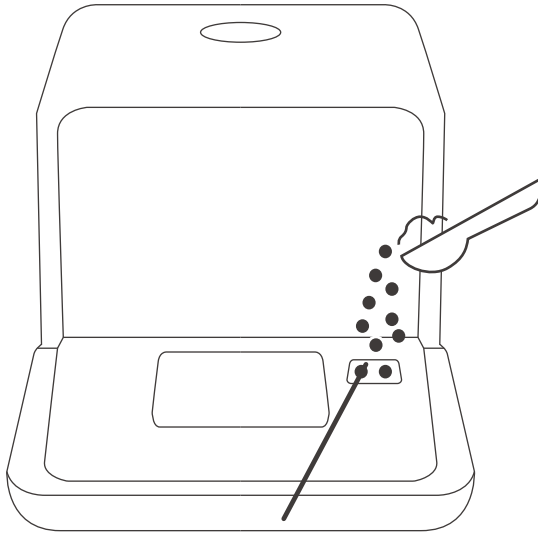

Detergent Cup

WASH CYCLE SELECTION

Wash Cycle Programs

The table below shows which programs are best for the levels of food residue on them and how much detergent is needed. It also show various information about the programs.

Program	Cycle Selection Information	Description Of Cycle	Detergent	Time (min)
NORMAL	This is standard program, it is suitable to clean normally soiled tableware and it is the most efficient program in terms of its combined energy and water consumption for that type of tableware.	Wash(140 °F) Rinse Rinse Rinse(158 °F) Drying	7.9g	130
RAPID	A shorter wash for lightly soiled loads and quick wash.	Wash (122 °F) Rinse Rinse Rinse	7.9g	40
Baby Care	Suitable for washing baby bottles. (Steam Adding)	Wash(158 °F) Rinse Rinse Rinse(162 °F) Drying	7.9g	120
FRUIT	Use to wash hard surface fruit, only manually adding cold water, not auto mode from the faucet.	Wash	/	20
GLASS	The temperature is suitable for delicate table ware with light soiled.	Wash (122 °F) Rinse Rinse Rinse (140 °F) Drying	7.9g	115

• Turning On The Appliance

Starting a wash cycle...

Draw out the basket(see the section entitled "Loading the Dishwasher").

Pour in the detergent (see the section"Fill the detergent").

Insert the plug into the socket. The power supply is 120VAC 60HZ,

Press the power button to turn on the appliance,

Connect the inlet hose to the tap, make sure that the water supply is turned on to full pressure, or add water to the tank manually.

Select a suitable program according to the "Wash cycle table";

If a program is selected, the response light will illuminate. Then press the Start/Cancel button, the dishwasher begins to start.

⚠ NOTE

When the dishwasher is paused during washing, the dishwasher will beep every minute as a reminder until the Start/Cancel button is pressed to restart or cancel the cycle

• Change The Program

A wash cycle can only be changed if it has been running for a short time otherwise, the detergent may have already been released and the dishwasher may have already drained the wash water. If this is the case, the dishwasher needs to be reset and the detergent dispenser must be refilled. To reset the dishwasher, follow the instructions below:

1. Press and hold Start/Cancel button for more than 3 seconds, the machine will be stand by state.
2. Press CYCLES button to select the desired program.
3. Add new detergent if the wash water was already spraying.
4. Press the Start/Cancel button, the dishwasher will start.

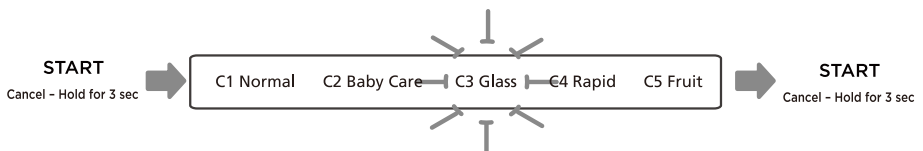

NOTE

If you open the door during washing, the machine will pause. When you and press the Start/Cancel Button, the machine will keep on working after 10 seconds.

• **Forgot to add a dish?**

A forgotten dish can be added up to 10 minutes after the cycle has been started. If this is the case, follow the instructions below:

1. Open the door a little to stop the moving.
2. After the spray arms stop working, you can open the door completely.
3. Add forgotten dishes.
4. Close the door.
5. Press the Start/Cancel button, the dishwasher will start working after 10 seconds.

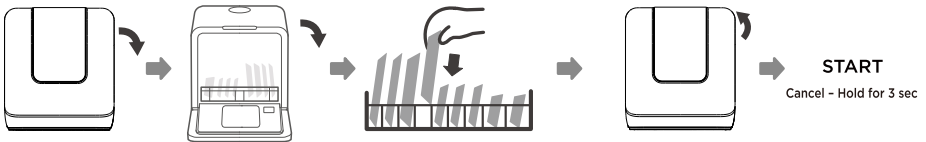

• End Of Wash Cycle

When the wash cycle has finished, the buzzer of dishwasher will sound 8 seconds, then stop. Wait a few minutes before unloading the dishwasher to avoid scalding the dishes and utensils are still hot and more susceptible to breakage. They will also dry better.

- **Switch Off the Dishwasher**

1. Switch off the dishwasher by pressing the ON/OFF button.
2. Turn off the water tap!

- **Open the door carefully**

The dishes should be allowed to cool down around 15 minutes before removing from the appliance.

Open the dishwasher's door, leave it ajar and wait a few minutes before removing the dishes. In this way they will be cooler and the drying will be improved.

- **Unloading the dishwasher**

It is normal that the dishwasher is wet inside.

⚠ WARNING

Open the door carefully when the dishwasher is washing. Only open the door slightly and wait for the wash water to settle before fully opening. The wash water is very hot and can cause scalding.

• Forced Internal Tank Draining

In standby mode, you can press and hold "DELAY" button + "AUTO OPEN" button for 3 seconds simultaneously to drain the water tank.

MAINTENANCE AND CLEANING

Filter System

⚠ WARNING

- **Never use the dishwasher without filters!**
- **Make sure the filter is properly assembled.**

The performance may be affected and dishes and utensils could become damaged.

The filter efficiently removes food particles from the wash water, allowing it to be recycled during the cycle.

For best performance and results, the filter assembly must be cleaned regularly. For this reason, it is a good idea to remove the larger food particles trapped in the filter after each wash cycle by rinsing the filter and cup under running water.

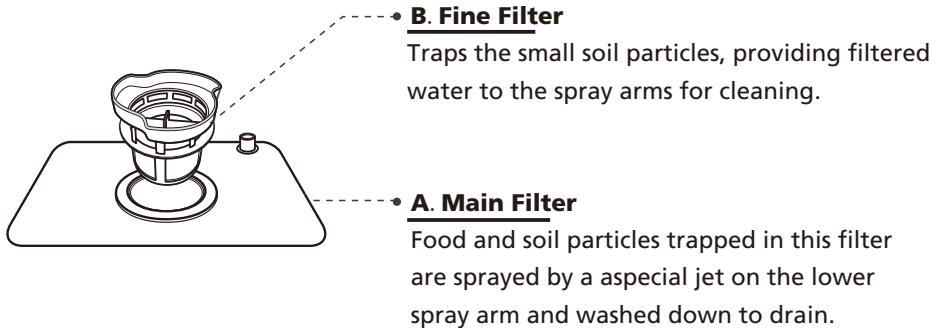

Step 1: Turn the filter assembly clockwise, then lift it up.



Step 2: Lift fine filter up and separate it from the main filter.

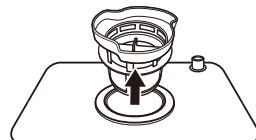

Step 3: Clean all of filter elements under running water to remove food soils.

⚠ NOTE

To re-install the filter system, complete Step 2 to Step 1.
The entire filter assembly should be cleaned once a week.

- Inspect the filters for blockages every time the dishwasher has been used.

⚠ WARNING

When cleaning the filters, don't knock on them. Otherwise, the filters could be damaged and the performance of dishwasher could be decreased.

• Dishwasher Care

The control panel and exterior can be cleaned by using a lightly dampened cloth. After cleaning, make sure to dry it thoroughly. Never use sharp objects, scouring pads or harsh cleaners on any part of the dishwasher.

Cleaning The Door

To clean the edge around the door, you should use only a soft warm, damp cloth. To avoid allowing water into the door lock and electrical components, do not use a spray cleaner of any kind.

⚠ WARNING

- Never use a spray cleaner to clean the door panel as it may damage the door lock and electrical components.
- Abrasive agents or rough paper towel should not be used because of the risk of scratching or leaving spots on the stainless steel surface.

Protect against freezing

Protect the dish washer from freezing temperatures. If the dishwasher will experience freezing temperature please follow the below procedure:

1. In standby mode, press and hold DELAY button + AUTO OPEN button for 3 seconds simultaneously to drain the water tank.
2. Cut off electrical power to the dishwasher.
3. Turn off the water supply and disconnect the water inlet pipe from the back of the dishwasher.
4. Drain water from the inlet pipe and dishwasher (use a pan to catch the water).
5. Disconnect drain hose, and drain water from hose and back of dishwasher (place a catch pan under connection before disconnecting to catch water).
6. Reconnect the water inlet pipe and drain hose to the back of the dishwasher.
7. Remove the filter at the bottom of the tub and use a sponge to soak up water in the sump.

⚠ NOTE

Damage due to freezing is not covered under the warranty.

Cleaning The Spray Arms

The spray arms can be easily removed for periodic cleaning of the nozzles to remove possible clogging. Wash them under running water and carefully replace them in their seats, checking that their rotary movement is in no way impeded.

Grasp the middle of the spray arm, pull it upwards to remove it. Wash the arms under a jet of running water and replace it carefully to its seat. After reassembly, check that the spray arms rotate freely and are snapped in securely.

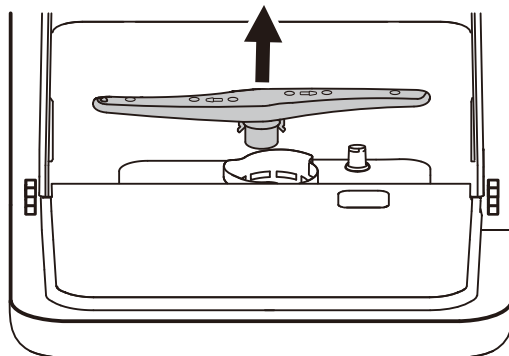

Dishwasher Maintenance

NOTE

Before cleaning or performing maintenance, always unplug the dishwasher to remove power.

After Every Wash

After every wash, turn off the water supply to the appliance and leave the door slightly open so that moisture and odors are not trapped inside.

Cleaning Best Practices

To clean the exterior and rubber parts of the dishwasher, do not use solvents or abrasive cleaning products. Only use a cloth with warm soapy water.

To remove spots or stains from the surface of the interior, use a cloth dampened with water and a little vinegar, or a cleaning product made specifically for dishwashers.

When Left Unused

It is recommended that you run a wash cycle with the dishwasher empty and then unplug from power, turn off the water supply and leave the door of the appliance slightly open. This will help the door seals last longer and prevent odors from forming within the appliance.

Moving the Appliance

If the appliance must be moved, try to keep it in vertical position to prevent water from draining from the dishwasher.

If transporting a long distance drain water from the interior tank and hoses:

1. Drain water from interior tank

In standby mode, press and hold DELAY button + AUTO OPEN button for 3 seconds simultaneously to drain the water tank.

2. Disconnect water inlet and drain hoses from the back of the dishwasher (place a catch pan under the connections before removing the hoses to catch any water).

3. Remove the filter at the bottom of the tub and use a sponge to soak up water in the sump.

INSTALLATION

⚠ WARNING



Electrical Shock Hazard

Disconnect electrical power before installing dishwasher.

Failure to do so could result in death or electrical shock.

⚠ Attention

The installation of the pipes and electrical equipments should be done by professionals.

• Installation preparation

The installation position of dishwasher should be near the existing water inlet tap and drain outlet and power socket.

One side of the sink should be chosen to secure the drain hoses of the dishwasher.

• Positioning the Appliance

The dishwasher is equipped with water supply and drain hoses that can be positioned to the right or the left to facilitate proper installation.

• About Power Connection

⚠ WARNING

For personal safety:

- Do not use an extension cord or an adapter plug with this appliance.
- Do not, under any circumstances, cut or remove the ground connection from the power cord.

Electrical Requirements

Please look at the rating label to know the rating voltage and connect the dishwasher to the appropriate power supply. Individual, properly polarized and grounded 10-amp(minimum) branchcircuit fused with 10-amp(minimum) time delay fuse or circuit breaker and provide separate circuit serving only this appliance.

Electrical Connection

Ensure the voltage and frequency of the power being corresponds to those on the rating plate. Only insert the plug into an electrical socket which is grounded properly. If the electrical socket to which the appliance must be connected is not appropriate for the plug , replace the socket, rather than using adaptors or the like as they could cause overheating and burns.

⚠ Ensure that proper grounding exists before use

• Water Connection

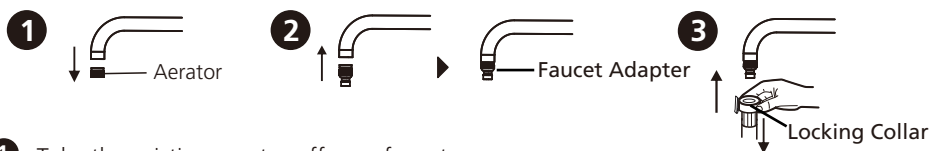

- 1 Take the existing aerator off your faucet.
- 2 Screw the faucet adapter onto (or into) the faucet tap. Check for leaks (Use Teflon tape)
Take the existing aerator off your faucet.
- 3 Attach the quick connect onto the faucet adapter by pulling down the locking collar.
Then pull up the locking collar to fix the connection.
- 4 Slowly open the hot water line and check for any sign of water leaks at all hose connections.

IMPORTANT: Please confirm whether the supplied adapter is suitable for your faucet tap. If not, please contact our customer service where adapter is available for purchase. Customer Service Phone: 1-866-646-4332

• Connection of drain hoses

Remove the rubber plug from the drain pipe at the rear of the machine. Install one end of drain hose to the drain pipe and then tighten the drain hose clamp by hand to secure it.

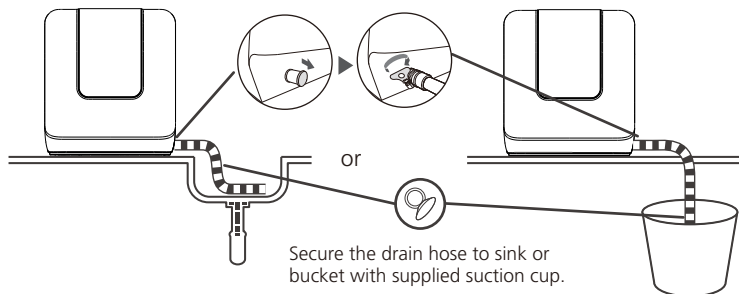

1. Remove the rubber plug from the drain pipe at the rear of the machine.
2. Install one end of drain hose to the drain pipe and then tighten the drain hose clamp by hand to secure it.
3. Place the free end of drain hose into a sink or bucket. Use the suction cup to hold the hose in place. (Note: the hose will shift when water is running if not secured)

The dishwasher drain hose should not be installed higher than 39 1/4" (1m) from the surface that the dishwasher is sitting on to prevent performance issues.

Note: If the drain hose is routed above the dishwasher it will hold water, and will need to be drained to be moved or relocated.

Caution: Do not extend the dishwasher hose more than 13" or 33cm to prevent performance issues. Any extension should be of the same material and diameter as the supplied drain hose.

Caution

The drain hose must be correctly fitted to avoid water leaks. Ensure that the water drain hose is not kinked or crushed.

TROUBLESHOOTING TIPS

• Before calling for service

Reviewing the charts on the following pages may save you from calling for service.

Problem	Possible Causes	What To Do
Dishwasher doesn't start	Fuse blown, or the circuit break tripped.	Replace fuse or reset circuit breaker. Remove any other appliances sharing the same circuit with the dishwasher.
	Power supply is not turned on.	Make sure the dishwasher is turned on and the door is closed securely. Make sure the power cord is properly plugged into the wall socket.
	Error code: E1; Water pressure is low	Check that the water supply is connected properly and the water is turned on.
	Door of dishwasher not properly closed.	Make sure to close the door properly and latch it.
Water not pumped from the dishwasher	Kinked or crushed drain hose.	Check the drain hose.
	Filter clogged.	Check filters.
	Kitchen sink clogged.	Check the kitchen sink to make sure it is draining well. If the problem is the kitchen sink that is not draining, you may need a plumber rather than a serviceman for dishwashers.
Drain hose routing is too high		The dishwasher drain hose should not installed higher than 39 1/4" (1m) from the surface that the dishwasher is sitting on to prevent performance issues.

Problem	Possible Causes	What To Do
Suds in the tub	Incorrect Detergent/ Soap	Remove all of the dishes from the dishwasher. Scoop out as much of the suds as you can with a plastic container. Add a cup of either olive oil or white vinegar, and run normal wash for a few minutes, and force a drain. Repeat as necessary until the foam is cleared, then run a complete Normal Cycle with no dishes.
	Spilled rinse-aid.	Always wipe up rinse-aid spills immediately.
Stained tub interior	Detergent with colorant may have been used.	Make sure that the detergent has no colorant.
White film on inside surface	Hard water minerals.	To clean the interior, use a damp sponge with dishwasher detergent and wear rubber gloves. Never use any other cleaner than dishwasher detergent otherwise, it may cause foaming or suds.
Rust stains on cutlery	The affected items are not corrosion resistant.	Avoid washing items that are not corrosion resistant in the dishwasher.
Knocking noise in the dishwasher	A spray arm is knocking against an item in a basket	Interrupt the program and rearrange the items which are obstructing the spray arm.
Rattling noise in the dishwasher	Items of crockery are loose in the dishwasher.	Interrupt the program and rearrange the dishware.
Knocking noise in the water pipes	Water hammer in household piping	This has no influence on the dishwasher function. If in doubt, contact a qualified plumber.
The dishes are not clean	The dishes were not loaded correctly.	See notes in "Loading & unloading your dishwasher".
	The program was not powerful enough.	Select a more intensive program.

Problem	Possible Causes	What To Do
The dishes are not clean.	Detergent	Use more detergent, or check the data of the detergent, or try a different brand of detergent.
	Items are blocking the movement of the spray arms.	Rearrange the items so that the spray can rotate freely.
	The filter combination is not clean or is not correctly fitted in the base of washcabinet. This may cause the spray arm jets to get blocked.	Clean and/or fit the filter correctly. Clean the spray arm jets.
Cloudiness on glassware.	Combination of soft water and too much detergent.	Use less detergent if you have soft water and select a shorter cycle to wash the glassware and to get them clean.
White spots appear on dishes and glasses.	Hard water area can cause limescale deposits.	Add more detergent.
Black or grey marks on dishes	Aluminium utensils have rubbed against dishes	Use a mild abrasive cleaner to remove marks.
Detergent left in dispenser	Dishes block detergent dispenser	Adjust the way dishes are loaded as to not block the detergent cup area
The dishes are not drying	Improper loading	Load the dishwasher as suggested in the directions.
	Dishes are removed too soon	Do not empty your dishwasher immediately after washing. Open the door slightly so that the steam can come out. Take out the dishes until the inside temperature is safe to touch.

• Error codes

The dishwasher will display error codes when it detects a malfunction with in its systems.

Codes	Meanings	Possible Causes
E1	Unit not receiving enough water	Check that the water supply is connected properly and the water is turned on.(Water tank not full?)
E3	Not reaching required temperature	Contact Customer Service to have a qualified technician repair your dishwasher
E4	Overflow.	Contact Customer Service to have a qualified technician repair your dishwasher

WARNING

- If overflow occurs, turn off the main water supply before calling a service.
- If there is water in the base pan because of an overfill or small leak, the water should be removed before restarting the dishwasher.

• Technical Information

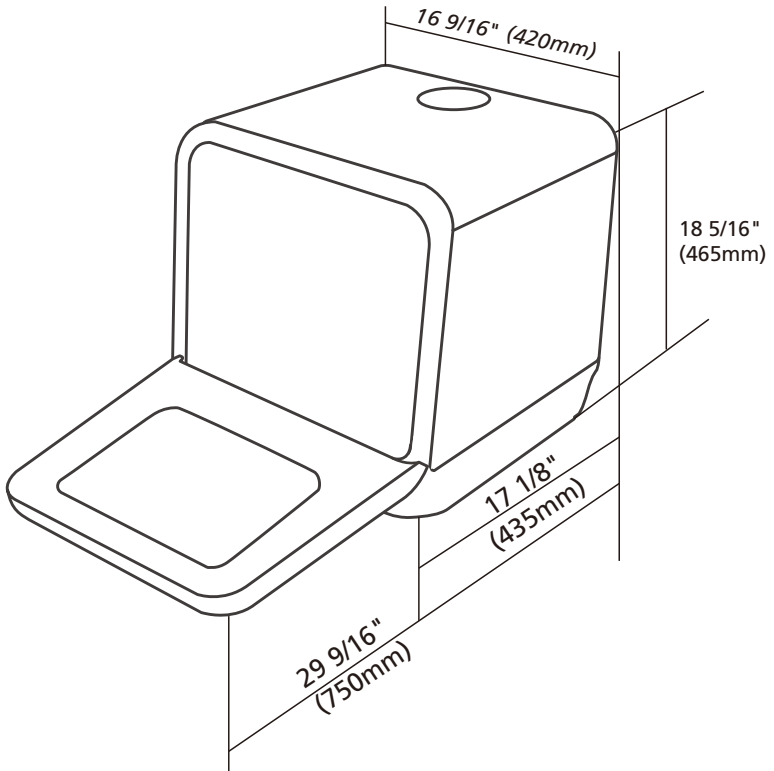

Height	18 5/16" (465mm)
Width	16 9/16" (420mm)
Depth	17 1/8" (435mm)
Water pressure	0.04 - 1.0MPa
Power supply	see rating label
Capacity	2 place setting(AHAM)

• **1 Year Limited Warranty**

This is the only express warranty for the product and in lieu of any other warranty or condition.

This product is warranted to be free from defects in material and workmanship for a period of one year from the date of original purchase. During this period, your exclusive remedy is repair or replacement of this product or any component found to be defective, at our option; however, you are responsible for all costs associated with returning the product to us and our returning the product or component under this warranty to you. If the product or component is no longer available, we will replace with a similar one equal or greater value.

This warranty does not cover wear from normal use, and operation doesn't conform to the instruction manual, or damages to the product resulting from accident, alteration, abuse, or misuse. This warranty extends only to the original consumer purchaser, or gift recipient. Keep the original sales receipt, as proof of purchase is required to make a warranty claim. This warranty is void if product is used for other than single-family household use or subjected to any voltage and waveform other than as specified on the label.

We exclude all claims for special, incidental, and consequential damages by breach of express or implied warranty. All liability is limited to amount of the purchase price. Every implied warranty, including any statutory warranty or condition of merchantability or fitness for particular purpose, is disclaimed except to the extent prohibited by law, in which case such warranty or condition is limited to the duration of this written warranty.

This warranty gives you specific legal rights. You may have other legal rights that vary depending on where you live. Some states or provinces do not allow limitations on implied warranties or special, incidental consequential damages, so the foregoing limitations may not apply to you.

Customer Service Phone: 1-866-646-4332

comfee'